

XT-Series Alternators

Designed for Recreational Applications

- 170A or 250A in a Small Case Package
- Up to 180A at Idle Speeds
- Patented Smart Ready® Technology
- Dual Fan Cooling, High Airflow Frame
- Ideal for Large Battery Banks
- USCG Title 33, ISO 8846 and SAE J1171 Certified



New XT-Series Alternators from Balmar bring together the latest innovations in alternator design to deliver incredible charging power in a compact, Marine & RV-friendly package.



Advanced Braided Stator

The **New XT-Series Alternator** family features a state-of-the-art, braided wire stator design to generate exceptional output in the smallest possible area. The XT-Series produces more power than our previous AT-Series designs and operates 5°-10°C cooler. In addition, we've added Balmar's Smart Ready® internal regulator technology to provide an additional level of fault tolerance for cruising boaters. Available XT-Series mounting styles have been expanded to include the "Vortec" 9Si design found on many GM gasoline engines.

XT-Series Alternators feature 96 slots - compared to 36 slots in a traditional S-wound stator – allowing the stator to develop superior electromagnetic energy and efficiency compared to traditional stator designs. The XT-170 and XT-250 are designed to deliver superior performance at idle speeds - up to 128A and 186A, respectively for 12V applications.

XT-Series Alternators may require a Tachometer Signal Stabilizer (Part No.05-1013) if your current tach is not adjustable. XT-Series Alternators should only be used in Dual Vee or Multi-Groove Serpentine belt configurations. Balmar's range of **AltMount® Serpentine Pulley Conversion Kits** support **XT-Series Alternators**.

					Kits	
6-Series Output	Power Taking Off	Mounting	Pulley	Alternator Only P/N	Kit with Max Charge Regulator	
170A, 12V	5.2 HP	Single Foot 1-2" Spindle	Dual Vee	05-3300	05-3400	
			K-6 Serpentine	05-3302	05-3402	
			J10 Serpentine	05-3308	05-3405	
250A, 12V	6.0 HP	Dual Foot 3.15" Saddle	Dual Vee	05-3301	05-3401	
			K-6 Serpentine	05-3303	05-3403	
			J10 Serpentine	05-3309	05-3406	
		Vortec Mount	K-6 Serpentine	05-3304	05-3404	
90A, 24V	5.2 HP	Single Foot 1-2" Spindle	Dual Vee	05-3312	05-3407	
			J10 Serpentine	05-3317	05-3414	
			Dual Vee	05-3313	05-3408	
		Dual Foot 3.15" Saddle	K-6 Serpentine	05-3315	05-3411	
		J10 Serpentine	05-3318	05-3415		
		Dual Foot 4" Saddle	Dual Vee	05-3327	05-3409	
			K-6 Serpentine	05-3328	05-3412	
90A, 24V	5.2 HP	Single Foot 1-2" Spindle	Dual Vee	05-3320	05-3416	
			K-6 Serpentine	05-3322	05-3418	
			J10 Serpentine	05-3325	05-3421	
		Dual Foot 3.15" Saddle	Dual Vee	05-3321	05-3417	
			K-6 Serpentine	05-3323	05-3419	
		J10 Serpentine	05-3326	05-3422		
		Vortec Mount	K-6 Serpentine	05-3324	05-3420	

How to Select the Correct Balmar Charging System for Your Vessel

Step 1: Determine your Electrical Load

All your device loads and expected duty cycles will clarify your expected daily battery discharge requirements. Add a safety factor.

Step 2: Identify your Battery Bank Technology and Capacity

How many batteries are in your bank and what is the total storage capacity?
 What type of batter chemistries are employed? (requiring different charge programs)

Step 3: Select your Alternator Output

The correct charging load depends on the battery chemistry and capacity.
 An AGM battery can accept a 40% charge load, so a 400Ah bank of AGMs can accept 160A of charging from the alternator. Note: Lithium batteries can accept an unlimited charge load.

Step 4: Identify the Alternator Mounting Style Present on your Engine

The most common mounting styles are shown to the right:		
(A) 1" Single Foot (Spindle Mount)	"Motorola Style"	Balmar XT-SF Series
(B) 2" Single Foot (Spindle Mount)	"Delco Style"	Balmar XT-SF Series
(C) 3.15" Dual Foot (Saddle Mount)	"Hitachi Style"	Balmar XT-DF Series
(D) 4" Dual Foot (Saddle Mount)	"J-180 Style"	Balmar XT-DF4 Series
(E) GM Delco Vortec Mount	"Vortec Style"	Balmar XT-VT Series

Step 5: Determine your Belt and Pulley Requirements

An Altmount® belt/pulley conversion kit may be required to handle your alternator Power Take-Off ("PTO") load.

Detailed toolsets for calculating loads and selecting the appropriate charging system for your vessel are available in the Balmar Catalog or at www.balmar.net

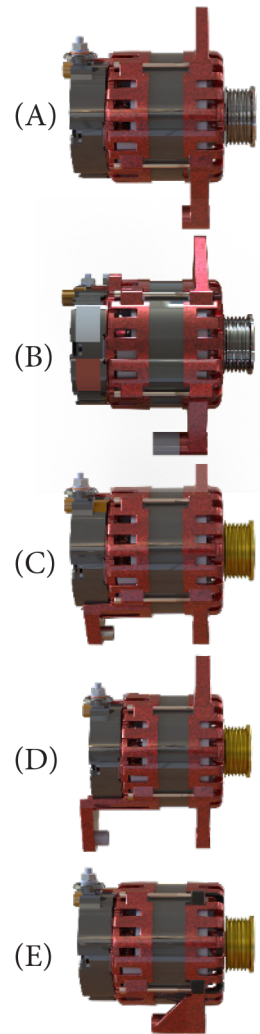

XT-Series Alternator Specifications

Alternator Style: Small Case, Positive Field Excitation (P-Type)	Mounting Styles: XT-VT Series: Delco Vortec Style XT-SF Series: 1" or 2" Single Foot (Spindle) XT-DF Series: 3.15" Dual Foot (Saddle) XT-DF4 Series: 4" Dual Foot (Saddle)(XT-250 Only)
Regulation: External P-Type (MC-618) XT-Series Includes an Internal Smart Ready® Voltage Regulator	Positive Output: Threaded Stud Dimensions: XT-170 & XT-250: M8 x 1.25
Cooling: Dual Internal Fans	Grounding: Case Ground XT-170 Isolated Ground Available on Request
Bearings: Sealed Bearings, Heavy Duty Radial (front & rear)	AC/Stator Output: 16 Poles Stator Output Wire included in Pigtail Plug
Case Construction: Ventilated Cast Aluminum	Diodes +/-: 6 Positive, 6 Negative; 50A Rated
Finish: Red Power Coat	Smart Ready® Internal Voltage Regulation: 14.1 Volts (12V Systems)
Tensioning Arm Mount: XT-250 (not applicable) XT-170: Five Position Crown (3x: M8 x 1.25, 2x: 8mm)	Cut-In RPM: 170A: 1,150 rpm, 90A & 250A: 1,350 rpm Max Alternator RPM: 18,000 rpm
Mounting Foot Bore: XT-VT, DF, SF 2"-Series: 10mm (3/8") XT-SF 1", DF4-Series: 1/2"	Normal Operating Temperature: 180oF / 82oC Max Operating Temperature: 225oF / 108oC
Ignition Protection Ratings: USCG Title 33, SAE J1171, CE, ISO 8846	

Alternator Output Curves

Alternator output is dependent upon several factors: battery condition and capacity, wire size, engine horsepower and RPM, battery temperature and alternator temperature. Of these factors, alternator speed and temperature are most important. The following graph describes alternator output based on ambient (25°C) temperature in “sweep” and “saturated dwell” conditions. Test voltages are set at 13.5V.

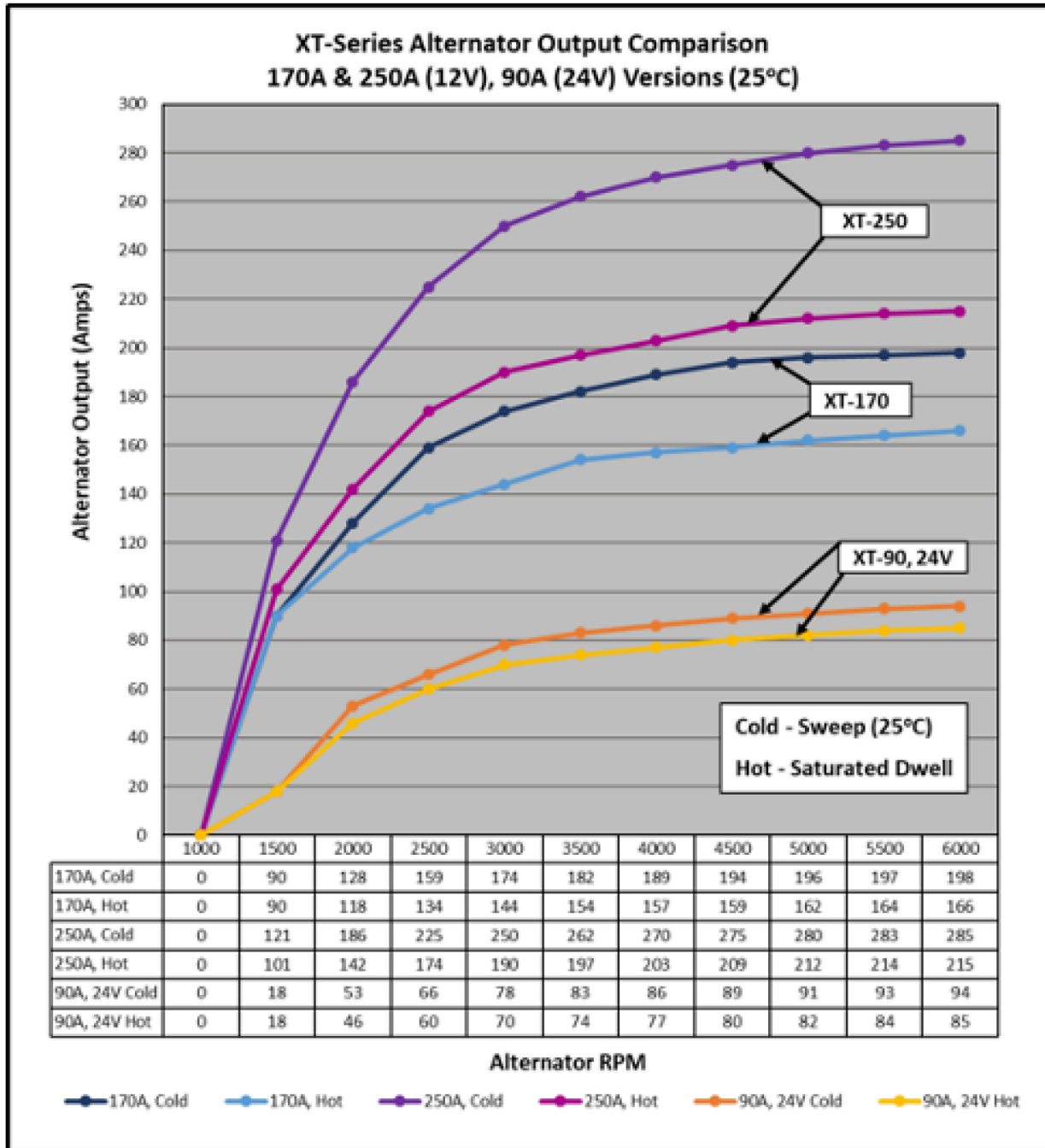

Balmar XT-Series Alternators and Charging Kits provide maximum charging power in a small case package suitable for installation in most small-to-medium sized diesel engines and most GM-based 4.3L to 8.1L gasoline engines.

Utilize the Balmar product configurator at www.balmar.net to locate a solution for your engine.

XT-170 Series Alternator Dimensions

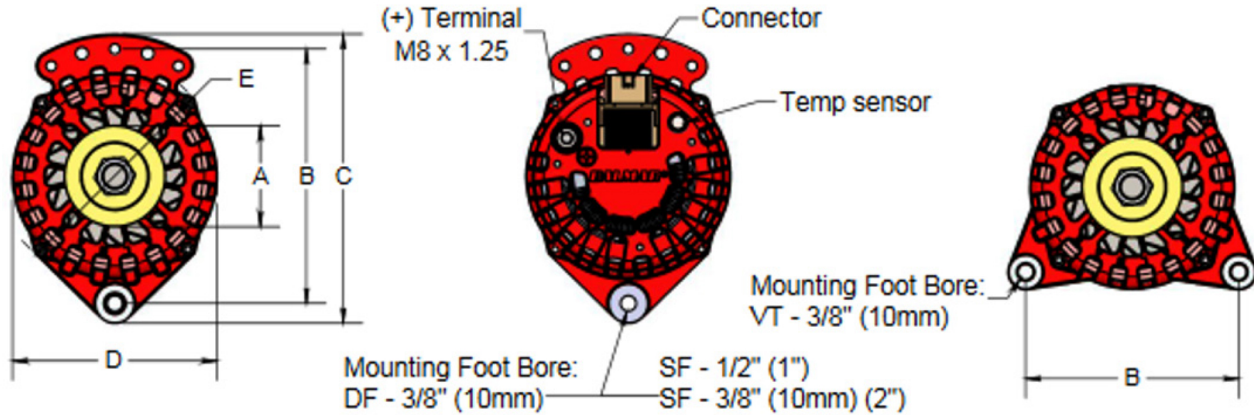

XT-SF-170-XX

XT-DF-170-XX

XT-VT-170-K6

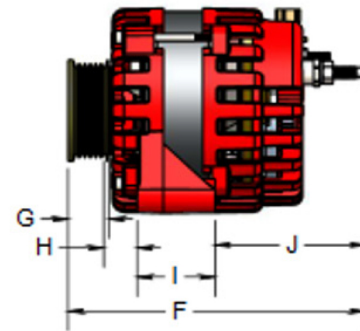
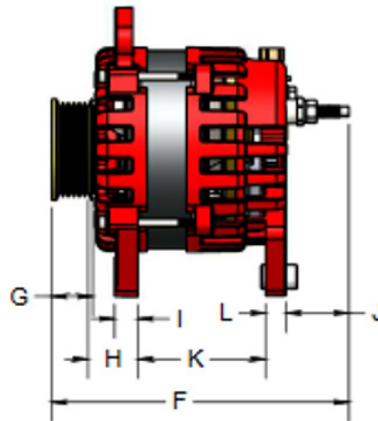
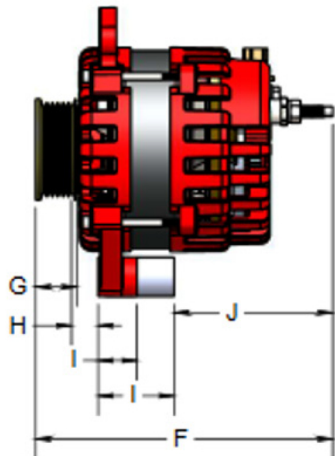

ITEM	DESCRIPTION	IN.	mm
A	Dual Vee (DV) Pulley Dia.	2.71	68
	K6 (serpentine) Pulley Dia.	2.42	61
	J10 (serpentine) Pulley Dia.	2.28	57
B	Mounting Hole (VT)	5.47	138
	Mounting Hole (SF)	6.53	165
C	Overall Height	7.43	188
D	Case Diameter	5.26	134
E	Mounting Ear to Mounting Ear	5.70	144
F	Overall Length w/ DV Pulley	8.00	203
	Overall Length w/ K6 Pulley	7.63	193
	Overall Length w/ J10 Pulley	7.86	99
G	DV Pulley Width	1.53	38
	K6 Pulley Width	1.18	29
	J10 Pulley Width	1.40	35

ITEM	DESCRIPTION	IN.	mm
H	First Groove to Mounting (SF)	0.68	17
	First Groove to Mounting (DF)	1.28	32
	First Groove to Mounting (VT)	0.85	21
I	Foot Thickness (SF) 1"	1.00	25
	Foot Thickness (SF) 2"	1.95	49
	Foot Thickness (DF)	0.60	15
J	Foot Thickness (VT)	2.00	50
	Foot to (+) Terminal (SF) 1"	5.03	127
	Foot to (+) Terminal (SF) 2"	4.08	103
K	Foot to (+) Terminal (DF)	1.61	40
	Foot to (+) Terminal (VT)	3.86	98
	DF Saddle Width (MIN)	2.88	73
L	DF Saddle Width (MAX)	3.28	83
	DF Saddle Width	3.15	80
L	Rear Foot Thickness	0.52	13

Dimensions are provided for illustrative purposes. Contact Balmar Technical Support if detailed drawings are required.

XT-250 Series Alternator Dimensions – Single Foot and Vortec Mounts

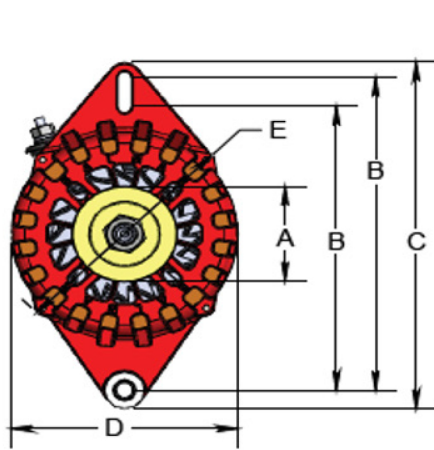

XT-SF-250-XX

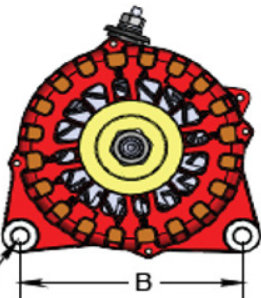
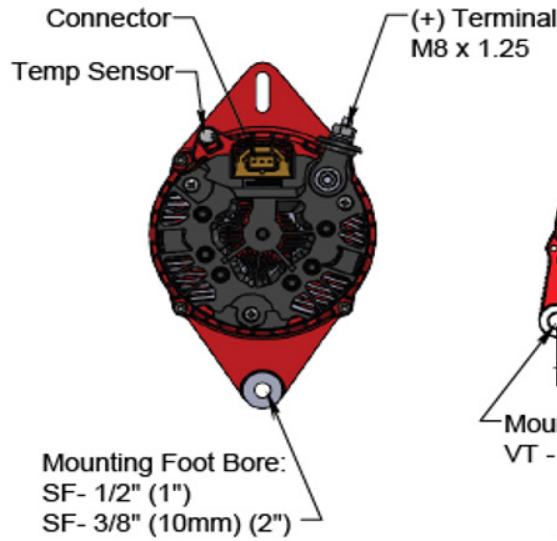

Mounting Foot Bore:
 VT - 3/8" (10mm)

XT-VT-250-XX

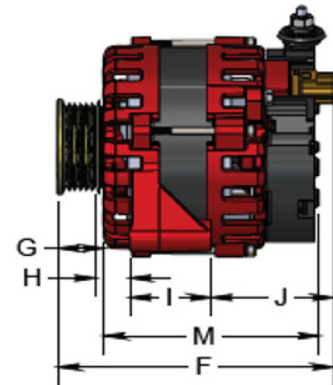
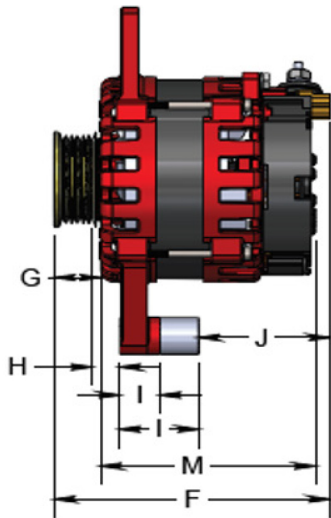

ITEM	DESCRIPTION	IN.	mm
A	Dual Vee (DV) Pulley Dia.	2.71	68
	K6 (serpentine) Pulley Dia.	2.42	61
	J10 (serpentine) Pulley Dia.	2.28	57
B	Mounting Hole to Hole (VT)	5.47	138
	Mounting Hole to Hole (SF Upper Slot)	8.50	216
	Mounting Hole to Hole (SF Lower Slot)	7.72	196
C	Overall Height (SF)	9.44	240
D	Case Diameter	5.59	142
E	Mounting Ear to Mounting Ear	6.10	154
F	Overall Length w/ DV Pulley	7.15	181
	Overall Length w/ K6 Pulley	6.80	172
	Overall Length w/ J10 Pulley	7.02	178

ITEM	DESCRIPTION	IN.	mm
G	DV Pulley Width	1.53	38
	K6 Pulley Width	1.18	29
	J10 Pulley Width	1.40	35
H	First Groove to Mounting (SF K6)	0.68	17
	First Groove to Mounting (SF J10)	0.75	18
	First Groove to Mounting (SF K6)	0.85	21
I	Foot Thickness (SF) 1"	1.00	25
	Foot Thickness (SF) 2"	1.95	49
J	Foot Thickness (VT)	2.00	50
	Foot Connector (SF) 1"	4.19	106
K	Foot Connector (SF) 2"	3.24	82
	Foot Connector (VT)	3.02	76
M	Front Housing to Rear Cover	5.30	134

Dimensions are provided for illustrative purposes. Contact Balmar Technical Support if detailed drawings are required.

XT-250 Series Alternator Dimensions – Dual Foot Mounts

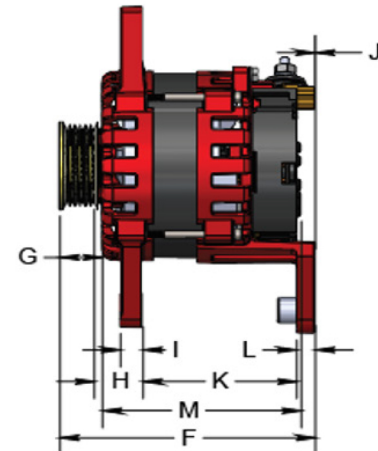
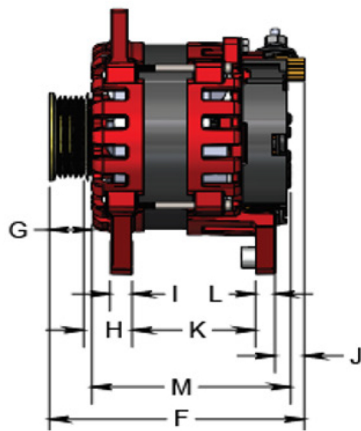
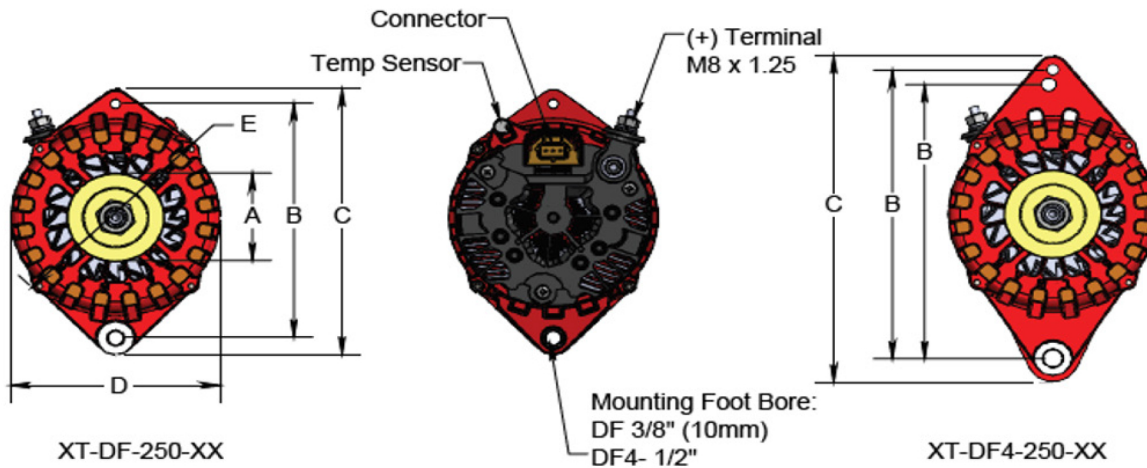

ITEM	DESCRIPTION	IN.	mm
A	Dual Vee (DV) Pulley Dia.	2.71	68
	K6 (serpentine) Pulley Dia.	2.72	61
	J10 (Serpentine) Pulley Dia.	2.28	57
B	Mounting Hole to Hole (DF)	6.88	175
	Mounting Hole to Hole (DF4 Upper)	8.50	216
	Mounting Hole to Hole (DF4)	8.07	205
C	Overall Height (DF)	7.81	198
	Overall Height (DF4)	9.61	244
D	Case Diameter	5.59	142
E	Mounting Ear to Mounting Ear	6.10	154
F	Overall Length w/ DV Pulley	7.15	181
	Overall Length w/ DV Pulley (DF4)	7.17	182
	Overall Length w/ K6 Pulley	6.80	172
	Overall Length w/ K6 Pulley (DF4)	6.81	173
	Overall Length w/ J10 Pulley	7.02	178
G	DV Pulley Width	1.53	38
	K6 Pulley Width	1.18	29
	J10 Pulley Width	1.40	35

ITEM	DESCRIPTION	IN.	mm
H	First Groove to Mounting (DF K6)	1.29	32
	First Groove to Mounting (DF J10)	1.36	34
	First Groove to Mounting (DF DV)	1.58	40
	First Groove to Mounting (DF4 K6)	1.29	32
	First Groove to Mounting (DF4 DV)	1.58	40
I	Foot Thickness (DF)	0.60	15
	Foot Thickness (DF4)	0.60	15
J	Foot Connector (DF)	0.78	19
	Foot Connector (DF4)	-0.02	-0.5
K	DF Saddle Width (MIN)	2.88	73
	DF Saddle Width (MAX)	3.28	83
	DF Saddle Width	3.15	80
	DF4 Saddle Width (MIN)	3.60	91
	DF4 Saddle Width (MAX)	4.10	104
L	DF4 Saddle Width	4.00	101
	Rear Foot Thickness (DF)	0.52	13
L	Rear Foot Thickness (DF4)	0.50	12
	M	Front Housing to Rear Cover	5.30

Dimensions are provided for illustrative purposes. Contact Balmar Technical Support if detailed drawings are required.